

Aqua Graze

CONTENTS

INTRODUCTION	2
Welcome	2
Safety, maintenance and cleaning	2
INSTALLATION	3
Aqua Graze mounting and adjusting	3
Aqua Driver mounting	4
Control input connections	4
Creating a wireless DMX input	5
Converting a 0-10V input	5
Output connections	6
Port connection cables	6
Fixture support with Aqua Driver 150	7
Fixture support with Aqua Driver 400	8
Connector pin outs	9
Fixture drive current selection	9
Port grouping	10
DMX channel layouts	11
Power input	14
Aqua Driver mode control	15
FURTHER INFORMATION	18
Aqua Graze and Driver specifications	18
Dimensions	19
Aqua Graze	19
Aqua Driver 150	20
Aqua Driver 400	21
Limited product warranty	22

INTRODUCTION

WELCOME

Welcome to the Aqua Graze and Aqua Driver from Acclaim Lighting. This range of high output, submersible LED flood fixtures offer IP68 submersible properties thanks to their anodized oxidation aluminum housings and fully sealed joints.

There are two sizes of fixture:

- Aqua Graze 1' with 12 LED emitters
- Aqua Graze 4' with 48 LED emitters

With a comprehensive choice of emitter types:

- 2700K, 3000K, 3500K or 4000K white
- Dynamic White (2400K to 5500K)
- RGBW (W=3000K, 4000K or 6000K)
- RGBA

And an appropriate range of lens options:

- 10° x 10°
- 10° x 60°
- 25° x 25°
- 30° x 60°
- 60° x 60°
- 90° x 90°

The accompanying Aqua Driver controllers (Aqua Driver 150 to control up to four fixtures; Aqua Driver 400 to control up to eight fixtures) operate from mains inputs ranging from 100 to 277VAC, 50/60Hz (autosensing) and provide constant current PWM drive to the output ports. The Aqua Driver units can either operate independently to provide static dimming or multiple chases, or can accept a DMX input for inclusion into an external control system.

The Aqua Driver units are housed within black power-coated steel enclosures with IP20 ratings for dry indoor locations. The driver units are designed to be wall mounted.

SAFETY

- Ensure that the power input is supplied from a correctly fused, earthed and environmentally protected location.
- While Aqua Graze fixtures are rated to IP68* for submersible operation, the Aqua Driver units have IP20 ratings, for dry location installations only.

MAINTENANCE

CAUTION: Always isolate mains power before starting maintenance operations.

- Ensure that all mounting (and device) screws/bolts are fully tight and free of corrosion.
- Ensure there is no deformation to the housing, lenses or fixing points.
- Check that all power supply cables are free from physical damage or material fatigue.
- Use only genuine spare parts supplied by Acclaim Lighting.

CLEANING

- Use a moist, lint-free cloth when cleaning each fixture.
- Never use alcohol or solvents.

INSTALLATION

AQUA GRAZE MOUNTING AND ADJUSTING

When installing Aqua Graze fixtures, ensure that the surface is level and that nothing is protruding to damage the mounting brackets. Suitable mounting surfaces include steel, aluminum, concrete or wood structures.

Each mount bracket has two slots measuring 0.39" x 0.18" (10 x 4.5mm) and the base has a thickness of 1/8" (3mm). Select bolts or screws (not supplied) that fit the mount bracket base(s) correctly and are particularly suited to the mounting surface.

The Aqua Graze can be tilted roughly 53° in each direction from vertical. Use a 1/8" (3mm) Allen wrench to loosen the tilt bolts on the mounting brackets at each end of the fixture.

If a mount bracket needs to be moved along the length of the fixture, you will need to temporarily remove the mount bracket base in order to gain access to the slide screw.

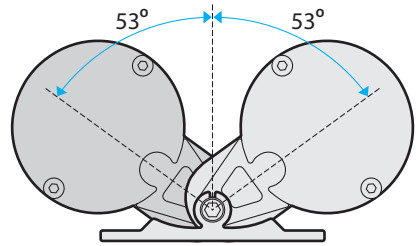

TO ADJUST THE MOUNT BRACKET

- 1 Use a 1/8" (3mm) Allen wrench to loosen the tilt bolt until the mount bracket base can be removed from the pillar:

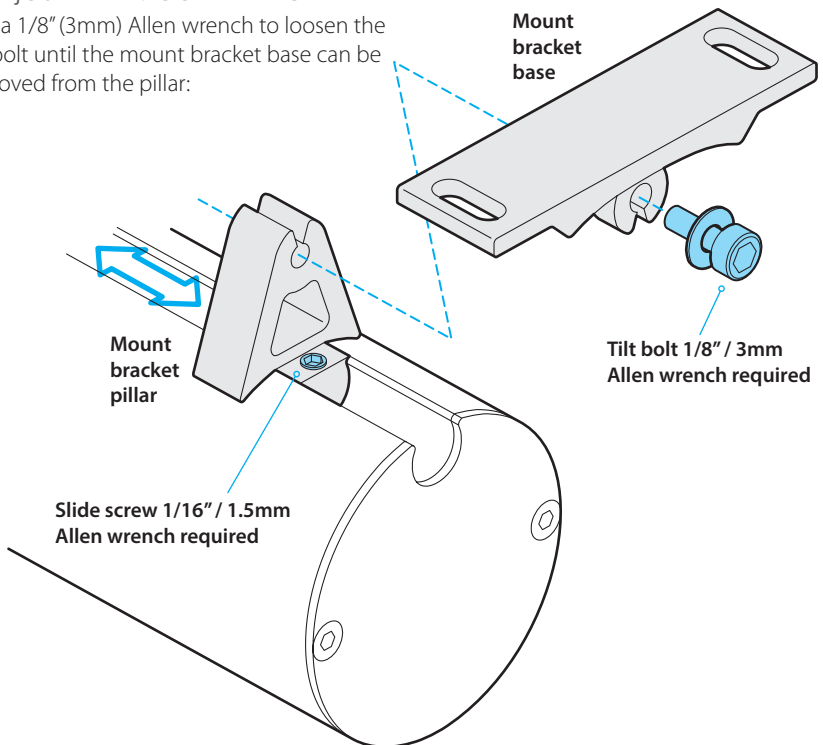

- 2 Use a 1/16" (1.5mm) Allen wrench to loosen the slide screw and move the pillar to the required position.
- 3 Re-tighten the slide screw.
- 4 Refit the base onto the pillar and tighten the tilt bolt.

AQUA DRIVER MOUNTING

Both Aqua Driver models can be wall mounted either vertically or horizontally as required. Two slotted holes (Ø 0.23" x 0.47" / Ø 6 x 12mm) are available on each side for mounting purposes - see "Dimensions" on pages 20 and 21.

CONTROL INPUT CONNECTIONS

Both Aqua Driver models can either operate in a standalone manner or be controlled by DMX. Three-pin terminal block IN and OUT ports are located on the front panel. In addition, the Aqua Driver 150 also provides 3-pin XLR IN and OUT sockets. See below for useful DMX tips. Connect your DMX cables to the terminal blocks as shown here:

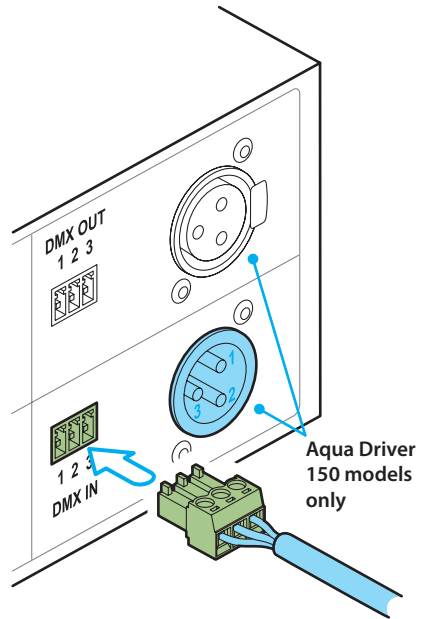
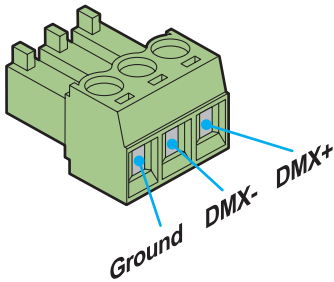

Insert the terminal block into the DMX socket and ensure that it fully clicks into place. Repeat for the DMX OUT if the control signal needs to be fed to another device.

TIPS FOR ACHIEVING SUCCESSFUL DMX CONTROL

- Do not exceed a total cable length of 3,900 ft (1200m) without buffering.
- Do not exceed a total of 32 devices/fixtures on a single line without buffering.
- Use only connection cables with a characteristic impedance of 120Ω, preferably where the DMX + and DMX – data lines are twisted around each other and the ground link exists as a coaxial screen surrounding the inner cores, such as Belden® 9842 or equivalent.
- Connect a 120Ω terminating resistor between the DMX + and DMX – output connections of the final fixture.
- Do not introduce a passive Y-split into the control cabling. If it is necessary to split the control link in order feed fixtures located in different directions, use a powered DMX splitter/buffer.
- Ensure that the DMX + and DMX – connections do not become crossed at any point.

CREATING A WIRELESS DMX INPUT

The optional Acclaim Lighting Aria units allow you create a wireless DMX link up to 2600 feet (792m) line of sight, between your control output and the Aqua Driver. Setup and configuration is straightforward:

- 1 Connect the DMX output of one Aria unit to the DMX input (using either the terminal block or the XLR connector) of the Aqua Driver.
- 2 Connect your DMX control source to the DMX input of the other Aria unit (when a valid signal is sensed, the Aria unit will automatically configure itself as a transmitter).
- 3 Ensure both Aria units are using the same radio channel.

The DMX signal presented at the transmitter will be replicated at the receiver and be fed to the Aqua Driver. See the *Aria Wireless DMX guide* for more details.

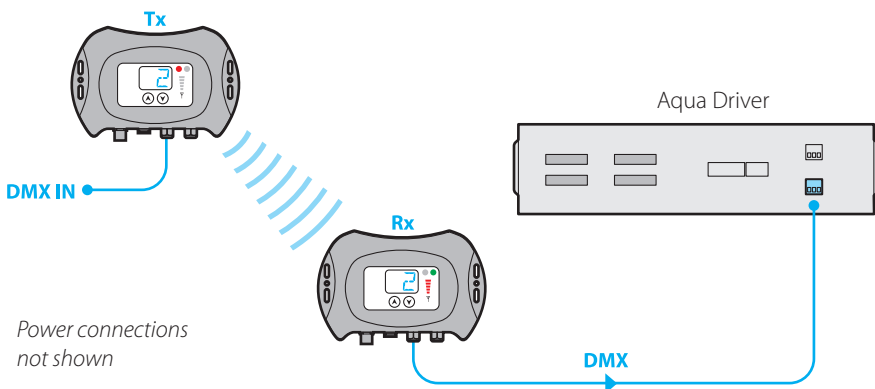

CONVERTING A 0-10V INPUT

The optional Acclaim Lighting UDM (Universal Dimming Module) unit allows you to collectively control a group of Aqua Graze fixtures using a 0-10V analog input. Setup and configuration is straightforward:

- 1 Connect the DMX output of the UDM unit to the DMX input (using either the terminal block or the XLR connector) of the Aqua Driver.
- 2 Connect your 0-10V control source to the appropriate input of the UDM unit.
- 3 Configure the UDM to perform the conversion. *Note: The UDM also has a mains power supply pass through to which the Aqua Driver can be connected; thus, only one mains input is required to supply the two devices.*

The 0-10V signal presented at the UDM will be converted into a single DMX channel and fed to the Aqua Driver; the Aqua Driver will need to be placed into 1 Group mode. The single channel input best suits Aqua Graze White emitters. See the *UDM guide* for more details.

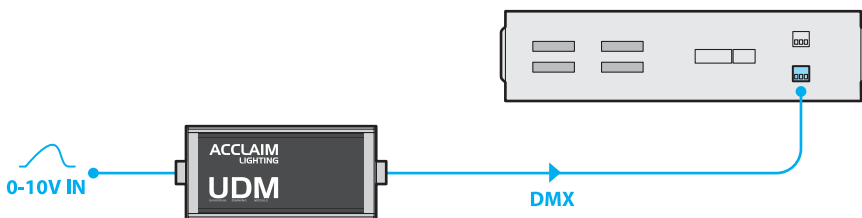

Power connections not shown

OUTPUT CONNECTIONS

The Aqua Drivers have multiple constant current output ports, each of which uses an 8-pin terminal block. Each output port provides multiple channels, the addressing of which are decided by the front panel switch settings (see “Aqua Driver mode control” on page 15).

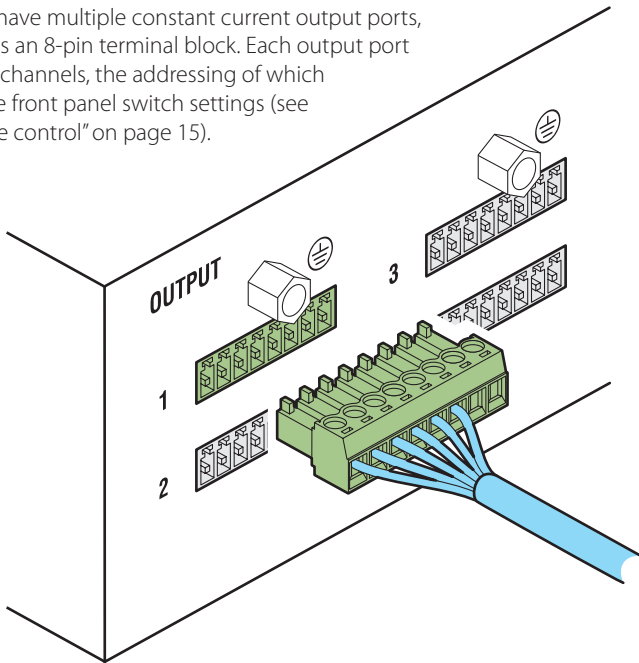

PORT CONNECTION CABLES

Each Aqua Graze fixture is supplied with a 98' (30m) cable terminated in an 8-pin terminal connector. In situations where this supplied cable is shortened and then wired into a separate supply cable, ensure the conductors of the supply cable are of sufficient size and that the total cable length (including that which remains of the Aqua Graze cable) is not exceeded:

Conductor size

- 18 AWG (0.823mm²)
- 14 AWG (2.081mm²)
- 12 AWG (3.309mm²)

Maximum length (including Aqua Graze cable)

- Up to 100' (30m)
- Up to 125' (38m)
- Up to 150' (45m)



1'

350mA



4'

700mA

IMPORTANT: 1' fixtures require a different drive current setting to the longer 4' fixtures - it is vitally important to select the correct setting to avoid damage to the fixtures. The drive current setting affects all outputs equally, so it is not possible to mix the two sizes on the same driver unit. See "Fixture drive current selection" on page 9.

FIXTURE SUPPORT WITH AQUA DRIVER 150

AQUA GRAZE 1' FIXTURES

Up to **four** Aqua Graze 1' fixtures can be used on a single Aqua Driver 150. Any of the port grouping options (*1 Group, 2 Group or 4 Group - see page 10*) are appropriate for these fixtures.

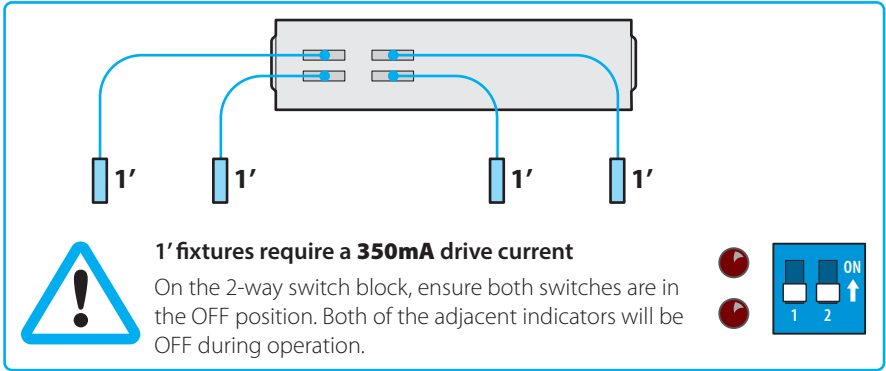

AQUA GRAZE 4' FIXTURES

A maximum of **two** Aqua Graze 4' fixtures can be used on a single Aqua Driver 150. Any of the port grouping options (*1 Group, 2 Group or 4 Group - see page 10*) are appropriate for these fixtures.

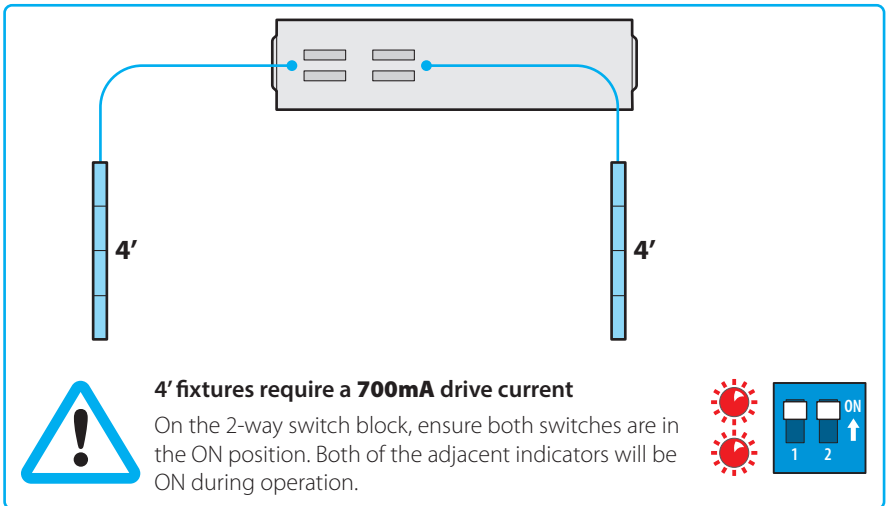

FIXTURE SUPPORT WITH AQUA DRIVER 400

AQUA GRAZE 1' FIXTURES

Up to **eight** Aqua Graze 1' fixtures can be used on a single Aqua Driver 400. Any of the port grouping options (1 Group, 2 Group, 4 Group or 8 Group - see page 10) are appropriate for these fixtures.

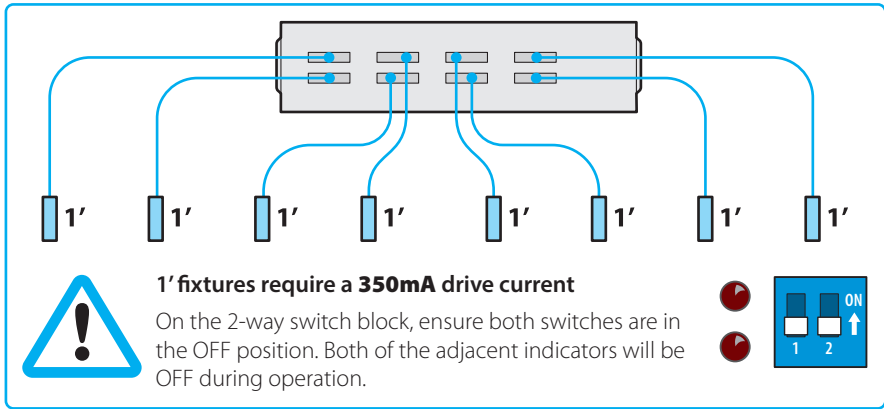

AQUA GRAZE 4' FIXTURES

Up to **eight** Aqua Graze 4' fixtures can be used on a single Aqua Driver 400. Any of the port grouping options (1 Group, 2 Group, 4 Group or 8 Group - see page 10) are appropriate for these fixtures.

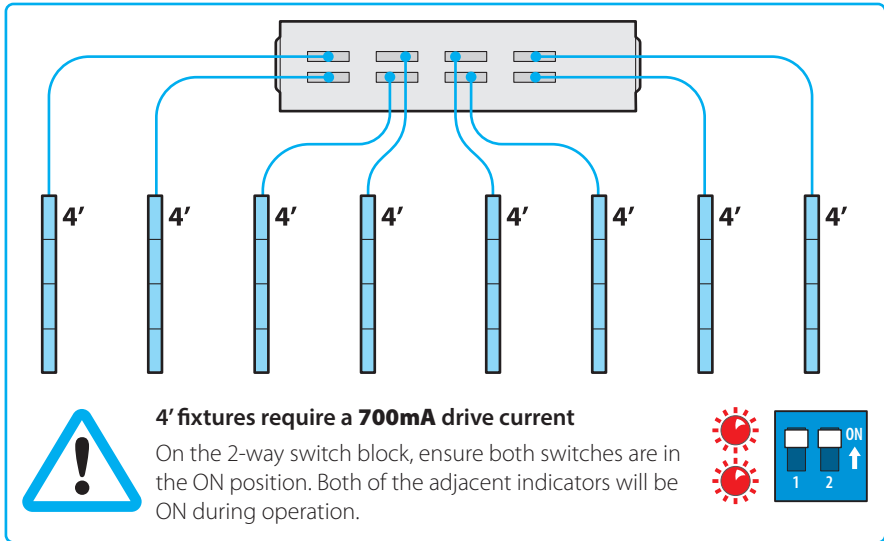

CONNECTOR PIN OUTS

AQUA GRAZE RGBW/A

These connections are used for RGBW/A versions of the EO, SO and HO Aqua Graze fixtures:

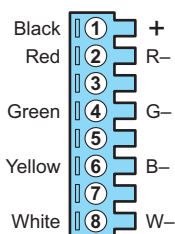

AQUA GRAZE WHITE AND DYNAMIC WHITE

These connections are used for White/DW versions of the EO, SO and HO Aqua Graze fixtures:

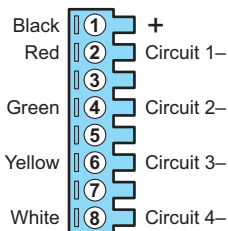

FIXTURE DRIVE CURRENT SELECTION



Aqua Graze 1' fixtures require a different drive current setting to the larger 4' fixtures - **it is vitally important to select the correct setting to avoid damage to the fixtures**. The drive current setting affects all outputs equally, so it is not possible to mix the 1' and 4' fixture lengths on the same driver.

Note: Changes to the drive current must be made while the Aqua Driver unit is powered down.

1' FIXTURES (350mA)

On the 2-way switch block, ensure both switches are in the OFF position. Both of the adjacent indicators will be OFF during operation.

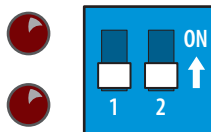

4' FIXTURES (700mA)

On the 2-way switch block, ensure both switches are in the ON position. Both of the adjacent indicators will be ON during operation.

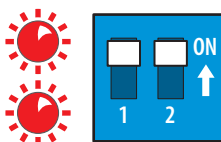

PORT GROUPING

AQUA DRIVER 150

The four output ports can either be used individually under separate control or grouped in either pairs, or grouped all as one control block. The grouping status is determined by switches 1 and 2 of the 6-way switch block (see page 15).

4 Group

All four ports are controlled individually:

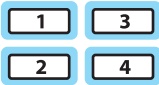

DMX channels required

White: 4 channels
DW: 8 channels
RGBW/A: 16 channels

2 Group

Ports 1 and 2 are controlled together as one group. Ports 3 and 4 are controlled as a separate group:

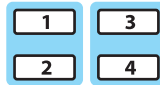

DMX channels required

White: 2 channels
DW: 4 channels
RGBW/A: 8 channels

1 Group

All four ports are controlled collectively:

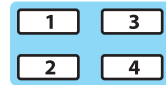

DMX channels required

White: 1 channel
DW: 2 channels
RGBW/A: 4 channels

AQUA DRIVER 400

The eight output ports can either be used individually under separate control or grouped in either pairs, fours or grouped all as one control block. The grouping status is determined by switches 1 and 2 of the 6-way switch block (see page 15).

8 Group

All eight ports are controlled individually:



DMX channels required

White: 8 channels
DW: 16 channels
RGBW/A: 32 channels

4 Group

The eight ports are paired and jointly controlled as follows: Ports 1 and 2, ports 3 and 4, ports 5 and 6, ports 7 and 8:

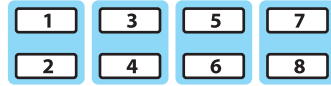

DMX channels required

White: 4 channels
DW: 8 channels
RGBW/A: 16 channels

2 Group

Ports 1, 2, 3 and 4 are controlled together as one group. Ports 5, 6, 7 and 8 are controlled as a separate group:



DMX channels required

White: 2 channels
DW: 4 channels
RGBW/A: 8 channels

1 Group

All eight ports are controlled collectively:



DMX channels required

White: 1 channel
DW: 2 channels
RGBW/A: 4 channels

DMX CHANNEL LAYOUTS

The number of DMX channels required to control the connected fixtures depends upon the following settings, which are configured using the 6-way switch block:

- Port grouping, and
- Fixture type

AQUA DRIVER 150

The various DMX channel requirements for the various port grouping and fixture type combinations on the Aqua Driver 150 are listed here:

DMX address	RGBW/A 4 Group	RGBW/A 2 Group	RGBW/A 1 Group
1	Port 1: Red	Ports 1 & 2: Red	All: Red
2	Port 1: Green	Ports 1 & 2: Green	All: Green
3	Port 1: Blue	Ports 1 & 2: Blue	All: Blue
4	Port 1: White/A	Ports 1 & 2: White/A	All: White/A
5	Port 2: Red	Ports 3 & 4: Red	
6	Port 2: Green	Ports 3 & 4: Green	
7	Port 2: Blue	Ports 3 & 4: Blue	
8	Port 2: White/A	Ports 3 & 4: White/A	
9	Port 3: Red		
10	Port 3: Green		
11	Port 3: Blue		
12	Port 3: White/A		
13	Port 4: Red		
14	Port 4: Green		
15	Port 4: Blue		
16	Port 4: White/A		

See "Port grouping" on page 10 and "External DMX control mode" on page 15 for DMX address configuration details.

DMX address	Dynamic White 4 Group	Dynamic White 2 Group	Dynamic White 1 Group
1	Port 1: Cool	Ports 1 & 2: Cool	All: Cool
2	Port 1: Warm	Ports 1 & 2: Warm	All: Warm
3	Port 2: Cool	Ports 3 & 4: Cool	
4	Port 2: Warm	Ports 3 & 4: Warm	
5	Port 3: Cool		
6	Port 3: Warm		
7	Port 4: Cool		
8	Port 4: Warm		

DMX address	White 4 Group	White 2 Group	White 1 Group
1	Port 1: White	Ports 1 & 2: White	All: White
2	Port 2: White	Ports 3 & 4: White	
3	Port 3: White		
4	Port 4: White		

AQUA DRIVER 400

The various DMX channel requirements for the various port grouping and fixture type combinations on the Aqua Driver 400 are listed here:

DMX address	RGBW/A 8 Group	RGBW/A 4 Group	RGBW/A 2 Group	RGBW/A 1 Group
1	<i>Port 1: Red</i>	<i>Ports 1 & 2: Red</i>	<i>Ports 1 to 4: Red</i>	<i>All: Red</i>
2	<i>Port 1: Green</i>	<i>Ports 1 & 2: Green</i>	<i>Ports 1 to 4: Green</i>	<i>All: Green</i>
3	<i>Port 1: Blue</i>	<i>Ports 1 & 2: Blue</i>	<i>Ports 1 to 4: Blue</i>	<i>All: Blue</i>
4	<i>Port 1: White/A</i>	<i>Ports 1 & 2: White/A</i>	<i>Ports 1 to 4: White/A</i>	<i>All: White/A</i>
5	<i>Port 2: Red</i>	<i>Ports 3 & 4: Red</i>	<i>Ports 5 to 8: Red</i>	
6	<i>Port 2: Green</i>	<i>Ports 3 & 4: Green</i>	<i>Ports 5 to 8: Green</i>	
7	<i>Port 2: Blue</i>	<i>Ports 3 & 4: Blue</i>	<i>Ports 5 to 8: Blue</i>	
8	<i>Port 2: White/A</i>	<i>Ports 3 & 4: White/A</i>	<i>Ports 5 to 8: White/A</i>	
9	<i>Port 3: Red</i>	<i>Ports 5 & 6: Red</i>		
10	<i>Port 3: Green</i>	<i>Ports 5 & 6: Green</i>		
11	<i>Port 3: Blue</i>	<i>Ports 5 & 6: Blue</i>		
12	<i>Port 3: White/A</i>	<i>Ports 5 & 6: White/A</i>		
13	<i>Port 4: Red</i>	<i>Ports 7 & 8: Red</i>		
14	<i>Port 4: Green</i>	<i>Ports 7 & 8: Green</i>		
15	<i>Port 4: Blue</i>	<i>Ports 7 & 8: Blue</i>		
16	<i>Port 4: White/A</i>	<i>Ports 7 & 8: White/A</i>		
17	<i>Port 5: Red</i>			
18	<i>Port 5: Green</i>			
19	<i>Port 5: Blue</i>			
20	<i>Port 5: White/A</i>			
21	<i>Port 6: Red</i>			
22	<i>Port 6: Green</i>			
23	<i>Port 6: Blue</i>			
24	<i>Port 6: White/A</i>			
25	<i>Port 7: Red</i>			
26	<i>Port 7: Green</i>			
27	<i>Port 7: Blue</i>			
28	<i>Port 7: White/A</i>			
29	<i>Port 8: Red</i>			
30	<i>Port 8: Green</i>			
31	<i>Port 8: Blue</i>			
32	<i>Port 8: White/A</i>			

See “Port grouping” on page 10 and “External DMX control mode” on page 15 for DMX address configuration details.

AQUA DRIVER 400 (CONTINUED)

DMX address	Dynamic White 8 Group	Dynamic White 4 Group	Dynamic White 2 Group	Dynamic White 1 Group
1	Port 1: Cool	Ports 1 & 2: Cool	Ports 1 to 4: Cool	All: Cool
2	Port 1: Warm	Ports 1 & 2: Warm	Ports 1 to 4: Warm	All: Warm
3	Port 2: Cool	Ports 3 & 4: Cool	Ports 5 to 8: Cool	
4	Port 2: Warm	Ports 3 & 4: Warm	Ports 5 to 8: Warm	
5	Port 3: Cool	Ports 5 & 6: Cool		
6	Port 3: Warm	Ports 5 & 6: Warm		
7	Port 4: Cool	Ports 7 & 8: Cool		
8	Port 4: Warm	Ports 7 & 8: Warm		
9	Port 5: Cool			
10	Port 5: Warm			
11	Port 6: Cool			
12	Port 6: Warm			
13	Port 7: Cool			
14	Port 7: Warm			
15	Port 8: Cool			
16	Port 8: Warm			

DMX address	White 8 Group	White 4 Group	White 2 Group	White 1 Group
1	Port 1: White	Ports 1 & 2: White	Ports 1 to 4: White	All: White
2	Port 2: White	Ports 3 & 4: White	Ports 5 to 8: White	
3	Port 3: White	Ports 5 & 6: White		
4	Port 4: White	Ports 7 & 8: White		
5	Port 5: White			
6	Port 6: White			
7	Port 7: White			
8	Port 8: White			

See “Port grouping” on page 10 and “External DMX control mode” on page 15 for DMX address configuration details.

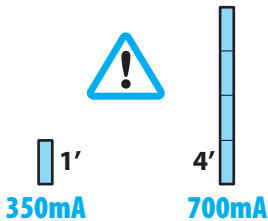

IMPORTANT: 1’ fixtures require a different drive current setting to the longer 4’ fixtures - it is vitally important to select the correct setting to avoid damage to the fixtures. The drive current setting affects all outputs equally, so it is not possible to mix the two sizes on the same driver unit. See “Fixture drive current selection” on page 9.

POWER INPUT

The fixed power cord is supplied as standard with US color coding and bare tails. For international installations, wire according to local codes.

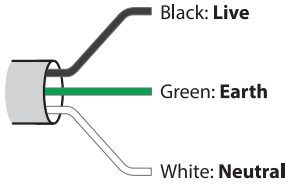

Power cord colors

The Aqua Driver power requirements are as follows:

- Voltage: 100-277VAC 50/60Hz

The red front panel indicator will illuminate when power is applied. The other two indicators located just below the power indicator are not used.

IN-RUSH CURRENT

The Aqua Drivers use switched mode power supplies which exhibit a trait known as 'in-rush current' when they are first powered on. This is caused by the various capacitive components initially topping themselves up with power. The in-rush current period lasts only milliseconds, however, if you are using multiple units on a single supply, ensure that the breakers used are rated to support inrush currents without tripping during startup.

AQUA DRIVER MODE CONTROL

The manner in which the Aqua Driver output ports are grouped and operate is determined by the settings of the three switch blocks located on the front panel. There are three main ways to use the Aqua Driver:

- External DMX control mode
- Standalone mode using internal chase programs
- Standalone mode using adjustable static dimming

EXTERNAL DMX CONTROL MODE

To allow DMX control you need to:

- 1 Set switch 10 of the 10-way switch block ON to choose DMX mode.

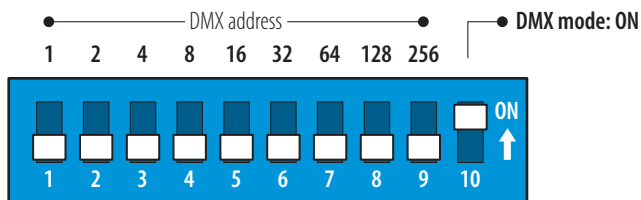

- 2 Select the required DMX base address using switches 1 to 9 of the 10-way switch block.

Each of the nine switches is 'weighted' with a value as shown here. Numerous apps are available to assist you with configuring the correct switch combinations for a given DMX address. *Note: The total number of DMX channels required for control will depend upon the chosen port grouping and fixture types (see "DMX channel layouts" on page 11).*

- 3 Use switches 1 and 2 of the 6-way switch block to choose the required grouping of channel outputs as required by the Aqua Grazes being connected and their required functions.

1	2	Port grouping	
		<i>Driver 150</i>	<i>Driver 400</i>
OFF	OFF	1 group	1 group
ON	OFF	2 group	2 group
OFF	ON	4 group	4 group
ON	ON	4 group	8 group

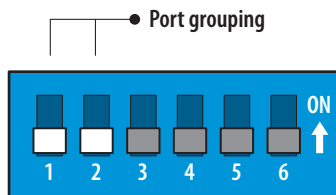

Note: Ensure the correct fixture current is selected - see page 9.

See "Port grouping" on page 10 for more details.

- 4 Use switches 4 and 5 of the 6-way switch block to set the type of Aqua Graze fixtures being used:

4	5	Fixture type
ON	OFF	White
OFF	ON	Dynamic White (DW)
ON	ON	RGBW/A

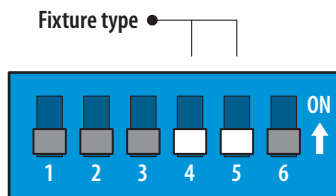

Note: The chosen fixture type (RGBW/A, DW or White) is applied globally to all ports. However, the electrical characteristics of the ports do not change (only their logical addressing configuration), so it is possible to mix white fixtures into an RGBW set up. As such, the various white emitters of the fixture would respond individually to the separate RGBW channel addresses.

STANDALONE MODE USING INTERNAL CHASE PROGRAMS

In standalone mode, all four ports are treated as one group. *Note: all switch settings can be changed when the driver is off or on.* To configure the Aqua Driver for standalone chase mode you need to:

- 1 On the 10-way switch block, set switch 10 OFF to choose standalone mode.

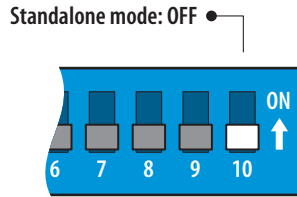

- 2 Use switches 1 to 3 of the 10-way switch block to choose the required fade time between chase steps. If all three switches are OFF, the chase states will snap between each other. All three switches ON will produce the smoothest fade (*Note: switch 3 is weighted as the most significant bit*).

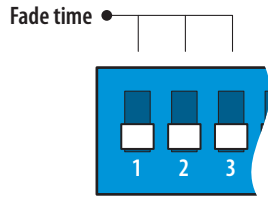

- 3 Use switches 4 to 6 of the 10-way switch block to choose the required speed of chase. If all three switches are OFF, the chase will run at its fastest speed, with 0.1 seconds between steps.

4	5	6	Speed
OFF	OFF	OFF	0.1 seconds
ON	OFF	OFF	0.2 seconds
OFF	ON	OFF	0.5 seconds
ON	ON	OFF	1 second
OFF	OFF	ON	5 seconds
ON	OFF	ON	10 seconds
OFF	ON	ON	20 seconds
ON	ON	ON	30 seconds

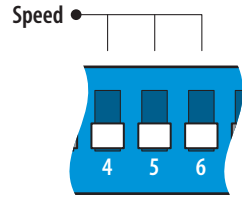

- 4 Use switches 7 to 9 of the 10-way switch block to choose the required program. If all three switches are ON, an Auto mode will cycle between all of the available programs.

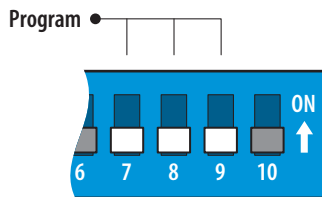

STANDALONE MODE USING ADJUSTABLE STATIC DIMMING

In standalone mode, all four ports are treated as one group. *Note: all switch settings can be changed when the driver is off or on.* To configure the Aqua Driver for standalone static dimming you need to:

- 1 On the 10-way switch block, set switch 10 OFF to choose standalone mode.

Standalone mode: OFF ●

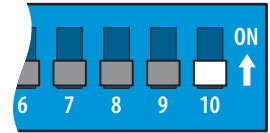

- 2 On the 6-way switch block, set switch 6 ON to choose manual dimming mode.

Manual dimming mode: ON ●

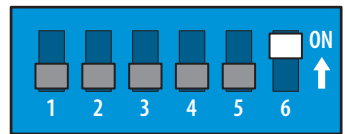

- 1 On the 10-way switch block, use switches 1 to 8 to choose the dimming level (for all emitters of every connected Aqua Graze fixture). When all eight switches are OFF, the fixtures will be at 0%; conversely, all switches ON will produce 100% output. The switches are arranged as a binary byte, with switch 1 as the least significant bit and switch 8 as the most significant.

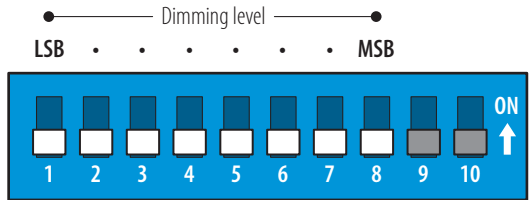

FURTHER INFORMATION

AQUA GRAZE AND DRIVER SPECIFICATIONS

AQUA GRAZE FIXTURES

Emitters	2700K, 3000K, 3500K or 4000K, or DW (2400K to 5500K) RGBW (W=3000K, 4000K or 6000K), RGBA
Optics	10° x 10°, 25° x 25°, 40° x 40°, 60° x 60°, 90° x 90°, 10° x 60° or 30° x 60°
Output	Up to 730 lumens per linear foot (3000K 10° x 60° variant)
Lumen maintenance (L ₇₀)	150,000 hours (25°C)
Control	DMX via Aqua Driver 150, 0-10V also possible using UDM
Operating voltage	24VDC constant current
Power consumption	12W (1' model), 48W (4' model)
Fixture cabling	98' (30m) STOW cable with terminal block termination
Housing	Anodized oxidation aluminum body, glass top lens
Mounting	53° swivel mounts included
Ingress protection	IP68, submersible up to 10' (3m)
Impact protection	IK06, protection against 1 joule impact
Operating temperature	-40°F to 122°F (-40°C to 50°C)
Weight	1.5 lbs/0.68kg (1' model), 6 lbs/2.72kg (4' model)
Certifications	



AQUA DRIVER 150 AND 400 CONTROLLERS

Control	DMX plus internal standalone chases and dimming
Input voltage	100 to 277VAC (50/60Hz) - auto sensing
Output	350 to 700mA constant current
Output ports	Aqua Driver 150: 4 (<i>see page 7</i>) Aqua Driver 400: 8 (<i>see page 8</i>)
Operating temperature	0°F to 158°F (-20°C to 70°C)
Housing	Aluminum
Ingress protection	IP20, indoor dry location
Impact protection	IK06, protection against 1 joule impact

DIMENSIONS

AQUA GRAZE

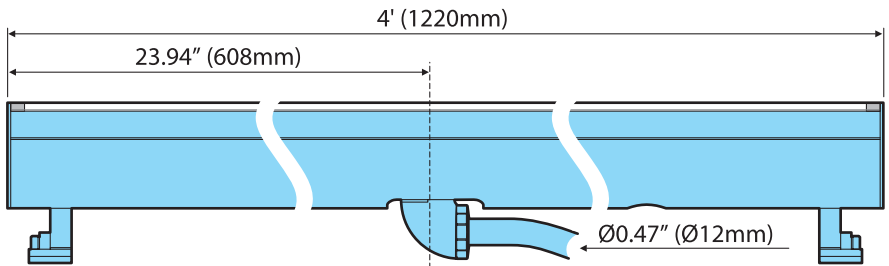
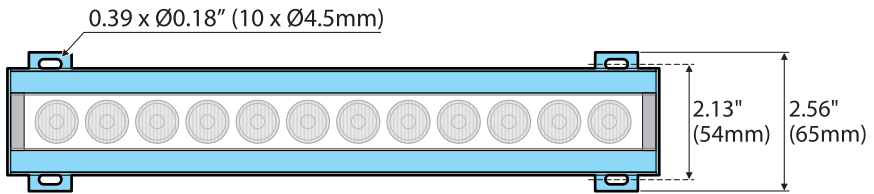
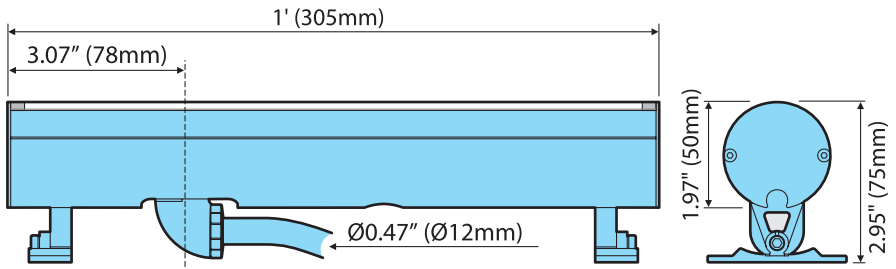

Fixture weights:

1' models: 1.5 lbs (0.68 kg)

4' models: 6 lbs (2.72 kg)

DIMENSIONS

AQUA DRIVER 150

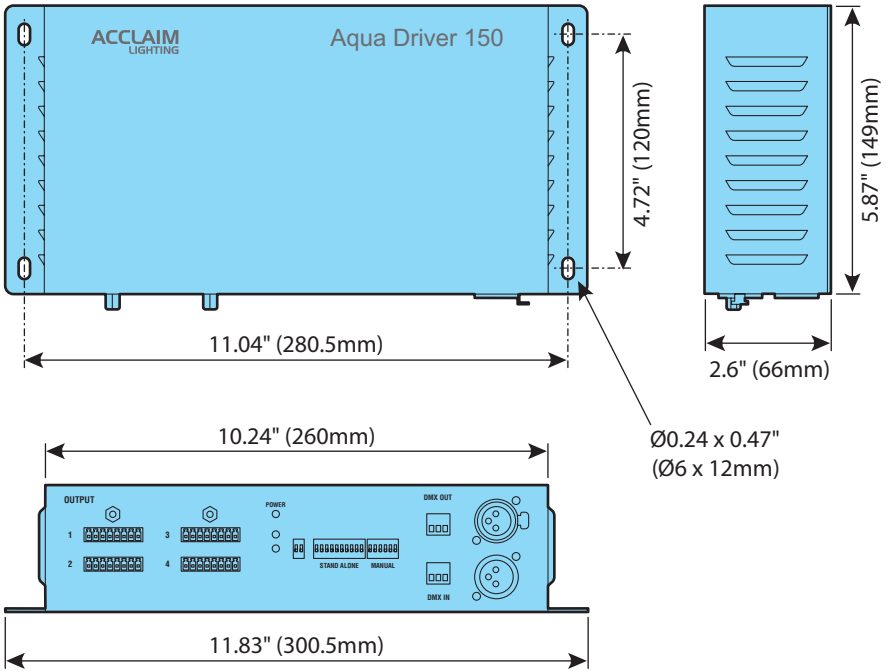

Weight: 2.6 lbs (1.18 kg)

DIMENSIONS

AQUA DRIVER 400

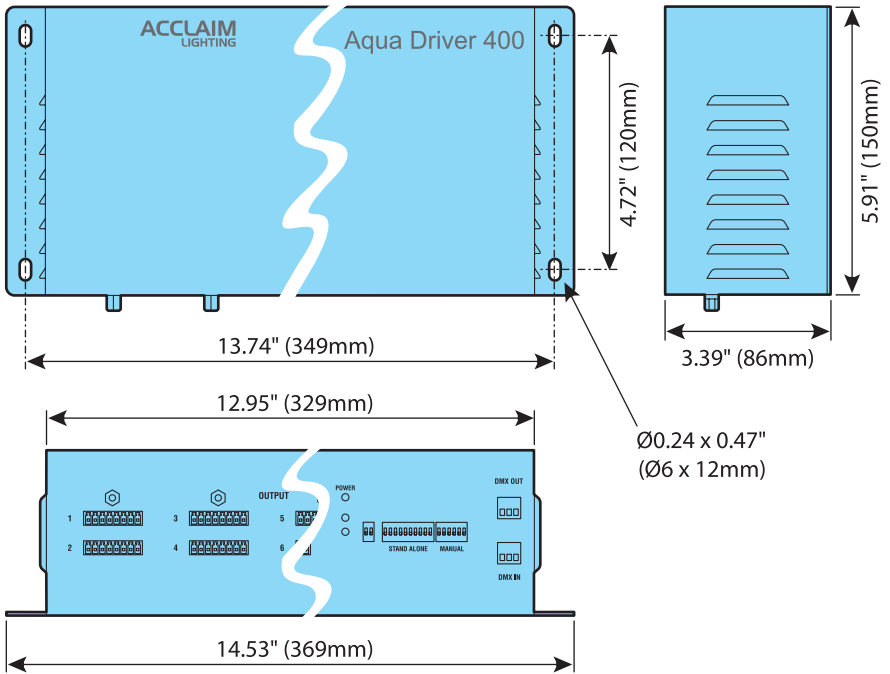

Weight: 4.4 lbs (1.99 kg)

LIMITED PRODUCT WARRANTY

A. Acclaim Lighting™ hereby warrants, to the original purchaser, Acclaim Lighting finished products to be free of manufacturing defects in material and workmanship for a standard period of:

- Fixtures: 5 Years (1,825 days) from the date of purchase.
- Drivers, power supplies and accessories: 5 Years (1,825 days) from the date of purchase.
- Flex Products: 3 Years (1,095 days) from the date of purchase.
- Controllers: 2 Years (730 days) from the date of purchase.

It is the owner's responsibility to establish the date and place of purchase and warranty terms by acceptable evidence, at the time service is sought.

B. For warranty service, send the product only to the Acclaim factory. All shipping charges must be pre-paid. If the requested repairs or service (including parts replacement) are within the terms of this warranty, Acclaim Lighting will pay return shipping charges only to a designated point within the United States. If the entire instrument is sent, it must be shipped in its original package. No accessories should be shipped with the product. If any accessories are shipped with the product, Acclaim Lighting shall have no liability whatsoever for loss of or damage to any such accessories, nor for the safe return thereof. Acclaim reserves the right to replace the item with same or similar product at its discretion.

C. This warranty is void if the serial number has been altered or removed; if the product is modified in any manner which Acclaim concludes, after inspection, affects the reliability of the product; if the product has been repaired or serviced by anyone other than the Acclaim Lighting factory unless prior written authorization was issued to purchaser by Acclaim Lighting; if the product is damaged because not properly maintained as set forth in the instruction manual.

D. This is not a service contract, and this warranty does not include maintenance, cleaning or periodic check-up nor do we guarantee as part of this warranty any lumen performance during period. Parts not covered by this warranty include: fuses, external power supplies, third party items not manufactures by Acclaim lighting. During the period specified above, Acclaim Lighting will replace defective parts at its expense, and will absorb all expenses for warranty service and repair labor by reason of defects in material or workmanship. The sole responsibility of Acclaim Lighting under this warranty shall be limited to the repair of the product, or replacement thereof, including parts, at the sole discretion of Acclaim Lighting. At no time will installation or re-installation or products labor or liability costs will be assumed by Acclaim Lighting. All products covered by this warranty were manufactured after January 1, 2012, and bear identifying serial number marks to that effect.

E. Acclaim Lighting reserves the right to make changes in design and/or improvements upon its products without any obligation to include these changes in any products theretofore manufactured. No warranty, whether expressed or implied, is given or made with respect to any accessory supplied with products describe above. Except to the extent prohibited by applicable law, all implied warranties made by Acclaim Lighting in connection with this product, including warranties of merchantability or fitness, are limited in duration to the warranty period set forth above. And no warranties, whether expressed or implied, including warranties of merchantability or fitness, shall apply to this product after said period has expired.

F. Marine or extreme weather location applications using Acclaim lighting products are subject to a 2 year limited warranty and Acclaim must be notified prior to delivery of units for such applications so that preventative treatment can be made to the products to ensure proper performance and product life with a special marine code coating / sealing process at an additional cost.

G. The consumer's and or dealer's sole remedy shall be such repair or replacement as is expressly provide above; and under no circumstances shall Acclaim Lighting be liable for any loss or damage, direct or consequential, arising out of the use of, or inability to use, this product. This warranty is the only written warranty applicable to Acclaim Lighting products and supersedes all prior warranties and written descriptions of warranty terms and conditions heretofore published.

www.acclaimlighting.com