

AQUA DRIVER 150 MOUNTING

The Aqua Driver 150 can be wall mounted either vertically or horizontally as required. Two slotted holes (Ø 0.23" x 0.47" / Ø 6 x 12mm) are available on each side for mounting purposes - see "Dimensions" on page 17.

CONTROL INPUT CONNECTIONS

The Aqua Driver 150 can either operate in a standalone manner or be controlled by DMX; IN and OUT ports are located on the front panel. Each port provides both a 3-pin terminal block plus a 3-pin XLR socket. See below for useful DMX tips. Connect your DMX cables to the terminal blocks as shown here:

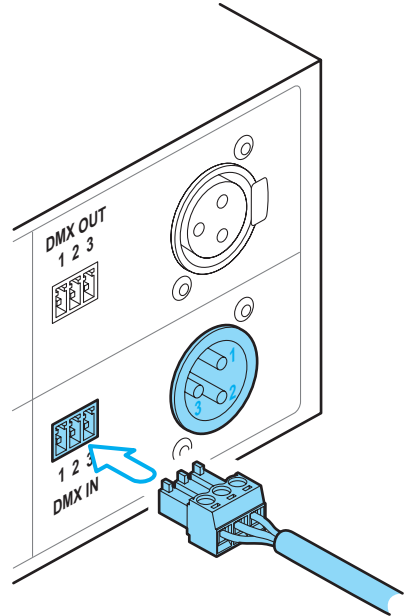
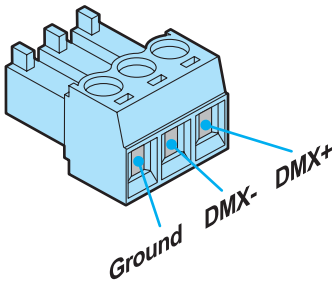

Insert the terminal block into the DMX socket and ensure that it fully clicks into place. Repeat for the DMX OUT if the control signal needs to be fed to another device.

TIPS FOR ACHIEVING SUCCESSFUL DMX CONTROL

- Do not exceed a total cable length of 3,900 ft (1200m) without buffering.
- Do not exceed a total of 32 devices/fixtures on a single line without buffering.
- Use only connection cables with a characteristic impedance of 120Ω, preferably where the DMX + and DMX – data lines are twisted around each other and the ground link exists as a coaxial screen surrounding the inner cores, such as Belden® 9842 or equivalent.
- Connect a 120Ω terminating resistor between the DMX + and DMX – output connections of the final fixture.
- Do not introduce a passive Y-split into the control cabling. If it is necessary to split the control link in order feed fixtures located in different directions, use a powered DMX splitter/buffer.
- Ensure that the DMX + and DMX – connections do not become crossed at any point.

CREATING A WIRELESS DMX INPUT

The optional Acclaim Lighting Aria units allow you create a wireless DMX link up to 2600 feet (792m) line of sight, between your control output and the Aqua Driver. Setup and configuration is straightforward:

- 1 Connect the DMX output of one Aria unit to the DMX input (using either the terminal block or the XLR connector) of the Aqua Driver.
- 2 Connect your DMX control source to the DMX input of the other Aria unit (when a valid signal is sensed, the Aria unit will automatically configure itself as a transmitter).
- 3 Ensure both Aria units are using the same radio channel.

The DMX signal presented at the transmitter will be replicated at the receiver and be fed to the Aqua Driver. See the *Aria Wireless DMX guide* for more details.

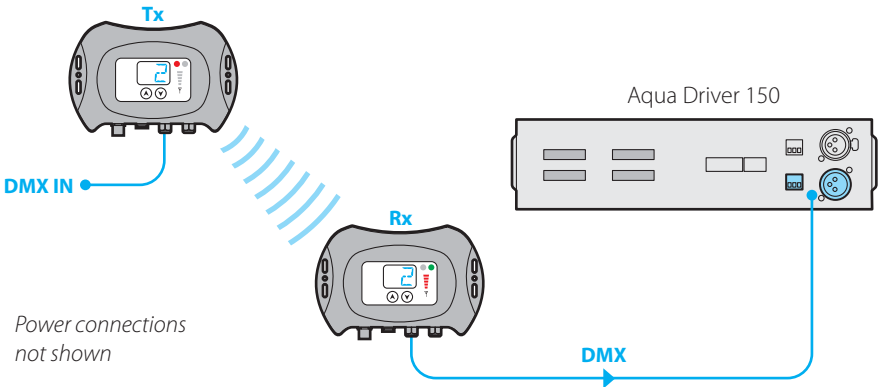

CONVERTING A 0-10V INPUT

The optional Acclaim Lighting UDM (Universal Dimming Module) unit allows you to collectively control a group of Aqua Graze fixtures using a 0-10V analog input. Setup and configuration is straightforward:

- 1 Connect the DMX output of the UDM unit to the DMX input (using either the terminal block or the XLR connector) of the Aqua Driver.
- 2 Connect your 0-10V control source to the appropriate input of the UDM unit.
- 3 Configure the UDM to perform the conversion. *Note: The UDM also has a mains power supply pass through to which the Aqua Driver can be connected; thus, only one mains input is required to supply the two devices.*

The 0-10V signal presented at the UDM will be converted into a single DMX channel and fed to the Aqua Driver; the Aqua Driver will need to be placed into *1 Group* mode. The single channel input best suits Aqua Graze White emitters. See the *UDM guide* for more details.

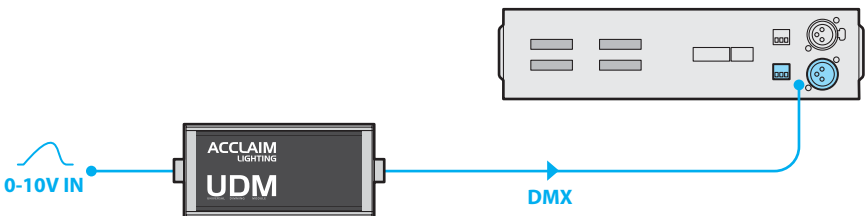

Power connections not shown

OUTPUT CONNECTIONS

The Aqua Driver 150 has four constant current output ports, each of which uses an 8-pin terminal block. Each output port provides multiple channels, the addressing of which are decided by the front panel switch settings (see “Aqua Driver 150 mode control” on page 12).

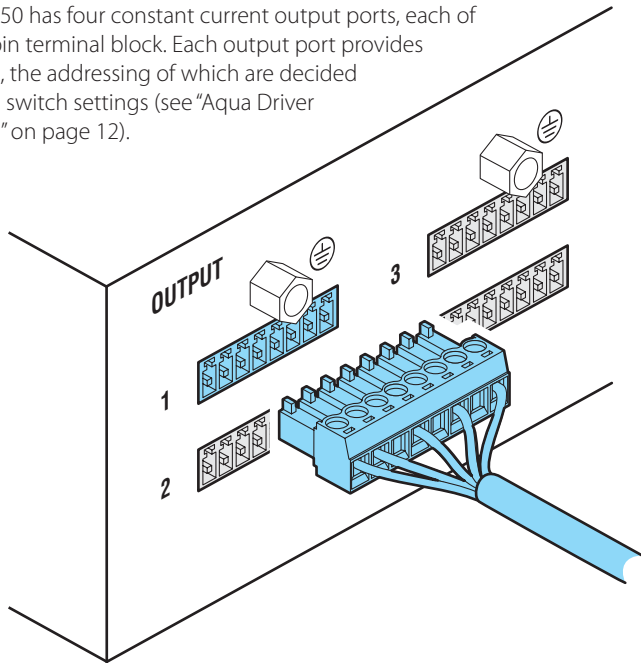

CONNECTOR PIN OUTS

AQUA GRAZE RGBW/A

These connections are used for RGBW versions of the Aqua Graze 1’ and 4’ fixtures:

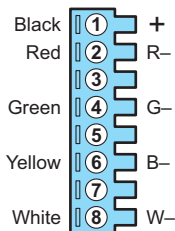

AQUA GRAZE WHITE

These connections are used for White versions of the Aqua Graze 1’ and 4’ fixtures:

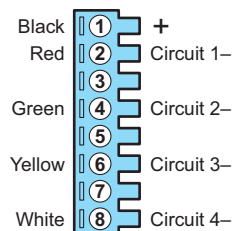

PORT CONNECTION CABLES

Each Aqua Graze fixture is supplied with a 98.4' (30m) cable terminated in an 8-pin terminal connector. In situations where this supplied cable is shortened and then wired into a separate supply cable, ensure the conductors of the supply cable are of sufficient size and that the total cable length (including that which remains of the Aqua Graze cable) is not exceeded:

Conductor size

- 18 AWG (0.823mm²)
- 14 AWG (2.081mm²)
- 12 AWG (3.309mm²)

Maximum length (including Aqua Graze cable)

- Up to 100' (30m)
- Up to 125' (38m)
- Up to 150' (45m)



1'
350mA

4'
700mA

IMPORTANT: 1' fixtures require a different drive current setting to the longer 4' fixtures - it is vitally important to select the correct setting to avoid damage to the fixtures. The drive current setting affects all outputs equally, so it is not possible to mix the two sizes on the same driver unit. See "Fixture drive current selection" on page 10.

IMPORTANT: Each Aqua Driver 150 unit can support up to four 1' fixtures OR a maximum of two 4' fixtures.

AQUA DRIVER 150 SUPPORT FOR FIXTURES

The Aqua Driver 150 can support up to four Aqua Graze 1' fixtures or a maximum of two Aqua Graze 4' fixtures:

AQUA GRAZE 1' FIXTURES

Up to **four** Aqua Graze 1' fixtures can be used on a single driver. Any of the port grouping options (1 Group, 2 Group or 4 Group - see page 10) are appropriate for these fixtures.

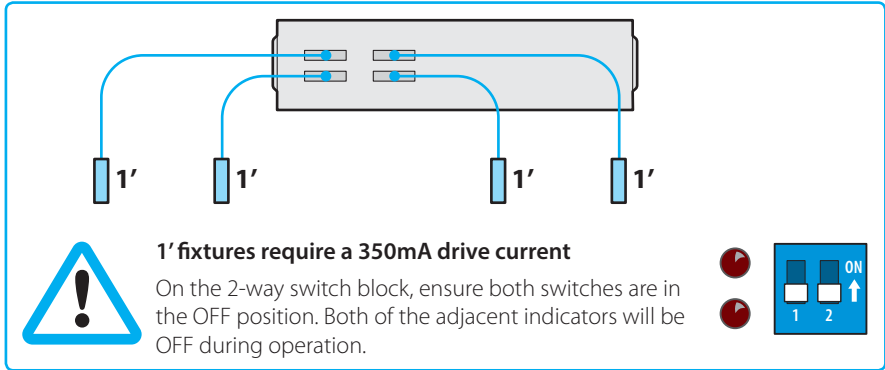

FOUR AQUA GRAZE HO FIXTURES

A maximum of **two** Aqua Graze 4' fixtures can be used on a single driver. Any of the port grouping options (1 Group, 2 Group or 4 Group - page 10) are appropriate for these fixtures.

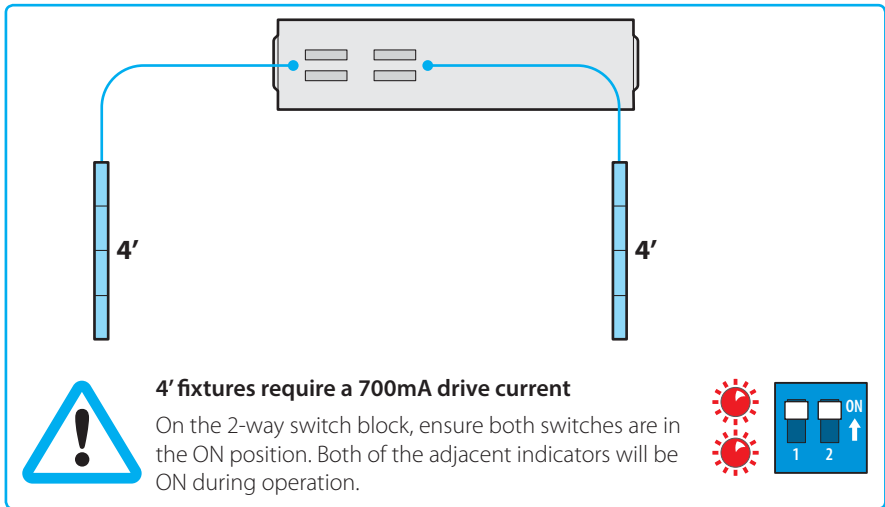

POWER INPUT

The fixed power cord is supplied as standard with US color coding and bare tails. For international installations, wire according to local codes.

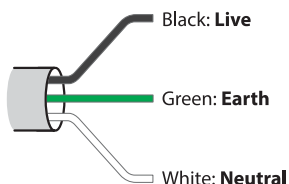

The Aqua Driver 150 power requirements are as follows:

- Voltage: 100-277VAC 50/60Hz

Power cord colors

The red front panel indicator will illuminate when power is applied. The other two indicators located just below the power indicator are not used.

IN-RUSH CURRENT

The Aqua Driver 150 uses a switched mode power supply which exhibits a trait known as 'in-rush current' when they are first powered on. This is caused by the various capacitive components initially topping themselves up with power. The in-rush current period lasts only milliseconds, however, if you are using multiple units on a single supply, ensure that the breakers used are rated to support inrush currents without tripping during startup.

CONFIGURATION

PORT GROUPING

The four output ports can either be used individually under separate control or grouped in either pairs, or grouped all as one control block. The grouping status is determined by switches 1 and 2 of the 6-way switch block (see page 12).

4 Group

All four ports are controlled individually:



DMX channels required

White: 4 channels
RGBW/A: 16 channels

2 Group

Ports 1 and 2 are controlled together as one group. Ports 3 and 4 are controlled as a separate group:



DMX channels required

White: 2 channels
RGBW/A: 8 channels

1 Group

All four ports are controlled collectively:



DMX channels required

White: 1 channel
RGBW/A: 4 channels

FIXTURE DRIVE CURRENT SELECTION



Aqua Graze 1' fixtures require a different drive current setting to the larger 4' fixtures - **it is vitally important to select the correct setting to avoid damage to the fixtures.** The drive current setting affects all outputs equally, so it is not possible to mix the 1' and 4' fixture lengths on the same driver.

Note: Changes to the drive current must be made while the Aqua Driver 150 unit is powered down.

1' FIXTURES (350mA)

On the 2-way switch block, ensure both switches are in the OFF position. Both of the adjacent indicators will be OFF during operation.

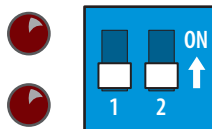

4' FIXTURES (700mA)

On the 2-way switch block, ensure both switches are in the ON position. Both of the adjacent indicators will be ON during operation.

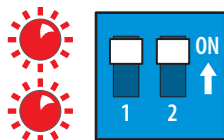

IMPORTANT: Each Aqua Driver 150 unit can support a maximum of two 4' fixtures.

DMX CHANNEL LAYOUTS

The number of DMX channels required to control the connected fixtures depends upon the following settings, which are configured using the 6-way switch block:

- Port grouping, and
- Fixture type

The various DMX channel requirements for the various port grouping and fixture type combinations are listed here:

DMX address	RGBW/A 4 Group	RGBW/A 2 Group	RGBW/A 1 Group
1	Port 1: Red	Ports 1 & 2: Red	All: Red
2	Port 1: Green	Ports 1 & 2: Green	All: Green
3	Port 1: Blue	Ports 1 & 2: Blue	All: Blue
4	Port 1: White	Ports 1 & 2: White	All: White
5	Port 2: Red	Ports 3 & 4: Red	
6	Port 2: Green	Ports 3 & 4: Green	
7	Port 2: Blue	Ports 3 & 4: Blue	
8	Port 2: White	Ports 3 & 4: White	
9	Port 3: Red		
10	Port 3: Green		
11	Port 3: Blue		
12	Port 3: White		
13	Port 4: Red		
14	Port 4: Green		
15	Port 4: Blue		
16	Port 4: White		

DMX address	White 4 Group	White 2 Group	White 1 Group
1	Port 1: White	Ports 1 & 2: White	All: White
2	Port 2: White	Ports 3 & 4: White	
3	Port 3: White		
4	Port 4: White		

See “Port grouping” on page 10 and “External DMX control mode” on page 12 for DMX address configuration details.

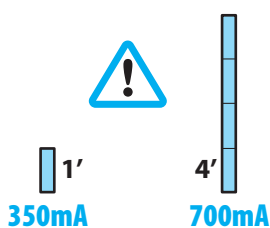

IMPORTANT: 1' fixtures require a different drive current setting to the longer 4' fixtures - it is vitally important to select the correct setting to avoid damage to the fixtures. The drive current setting affects all outputs equally, so it is not possible to mix the two sizes on the same driver unit. See “Fixture drive current selection” on page 10.

IMPORTANT: Each Aqua Driver 150 unit can support up to four 1' fixtures OR a maximum of two 4' fixtures.

AQUA DRIVER 150 MODE CONTROL

The manner in which the four output ports are grouped and operate is determined by the settings of the three switch blocks located on the front panel (*Note: all switch settings can be changed when the driver is off or on*). There are three main ways to use the Aqua Driver 150:

- External DMX control mode
- Standalone mode using internal chase programs
- Standalone mode using adjustable static dimming

EXTERNAL DMX CONTROL MODE

To allow DMX control you need to:

- 1 Set switch 10 of the 10-way switch block ON to choose DMX mode.

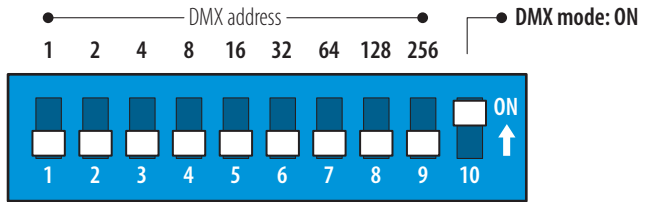

- 2 Select the required DMX base address using switches 1 to 9 of the 10-way switch

block. Each of the nine switches is 'weighted' with a value as shown here. Numerous apps are available to assist you with configuring the correct switch combinations for a given DMX address. *Note: The total number of DMX channels required for control will depend upon the chosen port grouping and fixture types (see "DMX channel layouts" on page 11).*

- 3 Use switches 1 and 2 of the 6-way switch block to choose the required grouping of channel outputs as required by the Aqua Graze fixtures being connected and their required functions.

1	2	Port grouping
OFF	OFF	1 combined group of four ports
ON	OFF	2 groups of two ports
OFF	ON	4 separate ports
ON	ON	4 separate ports

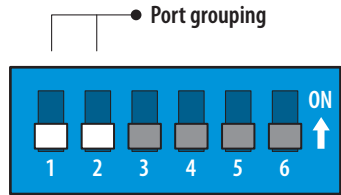

Note: Ensure the correct fixture current is selected - see page 10.

See "Port grouping" on page 10 for more details.

- 4 Use switches 4 and 5 of the 6-way switch block to set the type of Aqua Graze fixtures being used:

4	5	Fixture type
ON	OFF	White
ON	ON	RGBW/A

Note: The chosen fixture type (RGBW/A or White) is applied equally to all ports. However, the electrical characteristics of the ports do not change (only their logical addressing configuration), so it is possible to mix white fixtures into an RGBW set up. As such, the various white emitters of the fixture would respond individually to the separate RGBW channel addresses.

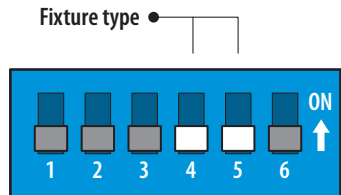

STANDALONE MODE USING INTERNAL CHASE PROGRAMS

In standalone mode, all four ports are treated as one group. *Note: all switch settings can be changed when the driver is off or on.* To configure the Aqua Driver 150 for standalone chase mode you need to:

- 1 On the 10-way switch block, set switch 10 OFF to choose standalone mode.

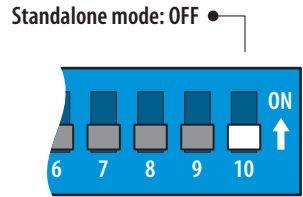

- 2 Use switches 1 to 3 of the 10-way switch block to choose the required fade time between chase steps. If all three switches are OFF, the chase states will snap between each other. All three switches ON will produce the smoothest fade (*Note: switch 3 is weighted as the most significant bit*).

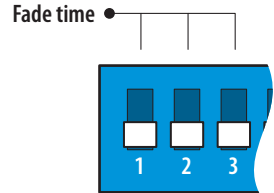

- 3 Use switches 4 to 6 of the 10-way switch block to choose the required speed of chase. If all three switches are OFF, the chase will run at its fastest speed, with 0.1 seconds between steps.

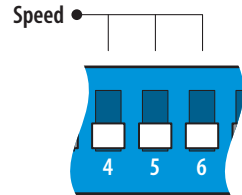

4	5	6	Speed
OFF	OFF	OFF	0.1 seconds
ON	OFF	OFF	0.2 seconds
OFF	ON	OFF	0.5 seconds
ON	ON	OFF	1 second
OFF	OFF	ON	5 seconds
ON	OFF	ON	10 seconds
OFF	ON	ON	20 seconds
ON	ON	ON	30 seconds

- 4 Use switches 7 to 9 of the 10-way switch block to choose the required program. If all three switches are ON, an Auto mode will cycle between all of the available programs.

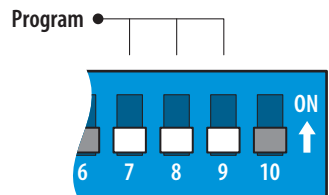

STANDALONE MODE USING ADJUSTABLE STATIC DIMMING

In standalone mode, all four ports are treated as one group. *Note: all switch settings can be changed when the driver is off or on.* To configure the Aqua Driver 150 for standalone static dimming you need to:

- 1 On the 10-way switch block, set switch 10 OFF to choose standalone mode.

Standalone mode: OFF ●

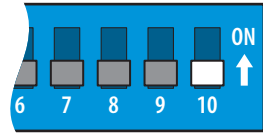

- 2 On the 6-way switch block, set switch 6 ON to choose manual dimming mode.

Manual dimming mode: ON ●

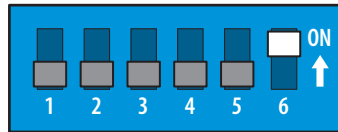

- 1 On the 10-way switch block, use switches 1 to 8 to choose the dimming level (for all emitters of every connected Aqua Graze fixture). When all eight switches are OFF, the fixtures will be at 0%; conversely, all switches ON will produce 100% output. The switches are arranged as a binary byte, with switch 1 as the least significant bit and switch 8 as the most significant.

